

Theodore E. Rose
Editor

J. F. Thompson
Associate Editor

J. B. Straughn
Technical Editor

L. L. Menne
Editor Emeritus

NRI NEWS

Vol. 18, No. 7

February-March, 1959

Published every other month by the National Radio Institute, 3939 Wisconsin Ave., N.W., Washington 16, D. C. Subscription \$1.00 a year. Printed in U.S.A. Second class postage paid at Washington, D. C.

Does Home Study Pay?

Ben Franklin once said, "If a man empties his purse into his head, no man can take it away from him. An investment in knowledge always pays the best interest."

Today, statistics prove that Ben knew what he was talking about. Recently a national magazine conducted a survey of 1,800 recent graduates from three of our largest home study schools. (Ed. note: NRI was one of these schools). Here are some of the results:

- *They increased their earnings—by an average of \$22.50 a week.
- *They won promotions or found new and better jobs.
- *They were well pleased with the content of the courses and the home study method.

Admittedly, the type of person who is ambitious enough to study in his spare time, and who has the ability to see an undertaking through to completion, is also a person you would expect to get ahead. But the knowledge gained through home study opens up new fields of endeavor. . . . unattainable by sheer drive alone.

Home study is not new—far from it! Our forefathers were well acquainted with this method. When schools were not available, books from Europe were diligently studied and many subjects mastered without any personal contact.

We are more fortunate today in that home study schools offer a wide range of subjects presented in easy-to-digest sections in a clear, concise manner. Practical instructions written by experienced educators are geared to prepare the student for the tasks he will face on-the-job. And the student may select only those subjects that he needs to round out his educational background.

It is no wonder that when asked if they would do it all over again, 85 per cent of the 1,800 graduates surveyed answered, "Yes!" *The Centralian*.



J. E. Smith

We're All
Mighty
Important

What is behind the attainment of most worthwhile things? For example, who really deserves the credit for training NRI's outstanding students and successful graduates?

We might mention our staff of textbook writers, constantly busy revising or writing new textbooks. Yes, they're important. They deserve part of the credit. Then there's our consultation staff ready to help you with your special problems, and our lesson graders, our student section, and a host of others working as a team, each responsible for a part of your training.

And YOU are on our team, too. Though NRI training methods have guided thousands of our graduates along the way to real success, we can only furnish the study material, and make tried and proved suggestions for its use. YOU are the one who makes this material meaningful. Only when this technical knowledge has been absorbed from our textbooks into YOUR mind does it become of value to YOU and to your prospective customers. It takes the efforts of all to make a good team. Each of us is mighty important.

J. E. Smith, Founder

It has been said: "A really wise man says nothing at the right time."



Thomas Carswell

Portable Receivers Using Transistors

By Thomas Carswell

NRI Consultant

In modern portable receivers, transistors have completely replaced vacuum tubes. Transistors are ideally suited for use in portables because they do not require heater current, they are rugged, and they can be operated from a comparatively low voltage source.

In modern portable receivers special parts are used along with the transistors. You will find that the i-f transformer in a portable receiver is much smaller than the i-f transformer in a broadcast-band receiver designed for use in the home. Other parts such as the output transformer, tuning capacitor, and oscillator coil are also usually smaller than the similar components in receivers designed for use from the power line. All these miniature parts, along with the small size of transistors, make it possible to manufacture portable receivers so small that they can easily be slipped into a man's shirt pocket.

Many portable receivers use etched circuit boards. The etched circuit board is made by gluing a thin sheet of copper to a phenolic board. The electrical connections to the various parts in the receiver are then printed on the board using an acid-resistant ink which covers the copper beneath it. The phenolic board with copper and the printing on it is then immersed in a chemical solution that eats all of the copper that is not protected by the acid-resistant ink. The board is then removed from the solution, washed, and the ink is then removed. A copper pattern will be left on the board, that takes the place of connecting wires.

This board is then dried and punched on a hydraulic punch. The punch puts holes in the board through which the various

parts can be mounted and soldered to the copper. Thus the receiver can be constructed without any wires; all the electrical connections between the various parts are made by the copper left on the circuit board.

A SIX-TRANSISTOR RECEIVER

A schematic diagram of a portable receiver using six transistors is shown in Fig. 1. The circuits used in this receiver are typical of those found in modern portable receivers. Let's review these circuits quickly. If you have gone very far in your course you have already studied most of these circuits and should be familiar with them; now we will see how they are used together in a complete receiver.

The input signal for this receiver is picked up by an antenna known as a Ferrite antenna. It consists of a coil wound on a core made of a powdered iron material called Ferrite. It has a very high Q, and hence the antenna has a high Q. Even a small Ferrite antenna is capable of comparatively high signal pickup.

In the receiver shown in Fig. 1, page 3, the Ferrite antenna has two windings on it, a primary winding and a secondary winding. The primary winding is tuned to resonance by the capacitor C18, which is connected across it. The capacitor is one section of the gang-tuning capacitor with a trimmer, which is marked T on the diagram, connected across it. The primary winding of the antenna is inductively coupled to the secondary winding. One side of the secondary winding is connected to ground, and the other side to the base of the transistor used in the converter circuit.

The 2N411 transistor shown in the converter circuit performs the dual function of mixer and oscillator. The oscillator signal is fed into the emitter circuit and is mixed in the transistor with the incoming local signal. In the converter, two new signals are produced, one equal to the sum of the frequencies of the incoming signal and the oscillator signal, and the other equal to the difference in frequency between them. As in the other superheterodyne receivers we have studied, the input i-f transformer T2 has its primary tuned to resonance at the difference frequency.

You will notice a crystal diode, marked CR2 and labeled "overload diode," connected to the collector circuit of the converter stage. We'll come back to this diode in a minute and explain what it does and how it is used.

The signal flowing through the primary winding of T2 induces a voltage in the secondary. This voltage is applied to the base of the first i-f transistor and to ground through the .05-mfd capacitor C4. The emitter of the first i-f stage is connected to ground through the .05-mfd capacitor C5. Since these capacitors have low reactances at the i-f signal frequency, we have the signal effectively applied between the base and emitter.

The signal is amplified by the first i-f transistor, and fed to the primary winding of the interstage i-f transformer T3. Notice that the primary winding of this transformer is tapped, and the B supply voltage is applied to the tap, which is terminal 6 of the transformer. The voltages at the opposite ends, terminals 3 and 4, of the primary winding will be 180 degrees out of phase. The signal from terminal 3 is fed through the 6.8-mmf capacitor C7 back to the base of the first i-f transistor to cancel out any signal fed from the collector circuit back into the input circuit through the transistor. This is a neutralizing circuit, and it is needed in order to prevent the stage from going into oscillation.

The signal current flowing through the primary of T3 induces a voltage in the secondary, and this voltage is applied to the second i-f transistor. One side of the secondary winding connects to the base, and the other to ground through the 10-mfd capacitor C12. The emitter of the second i-f transistor is connected to ground through the 45-mfd capacitor C10, so we have the signal applied between the base and the emitter of the second i-f amplifier. The signal is amplified by the second i-f amplifier and fed to the output i-f transformer T-4. Notice that the second

i-f amplifier is neutralized by the signal fed from terminal 3 of the output i-f transformer T-4, through the 3.3-mmf capacitor C9 to the base of the transistor.

Connected in the secondary circuit of the output i-f transformer T-4, we have the detector diode CR1. When the side of this diode that is connected to terminal 2 of the secondary is positive, the diode will conduct, and current will flow from ground through the volume control R13, through the 560-ohm resistor R21, through the diode detector. Current will then flow through the secondary of the output i-f transformer T-4, back to the secondary of T2, through the base-emitter junction of the first i-f transistor, through the 680-ohm resistor R-6, and back to ground.

This circuit back through the first i-f transistor provides AVC for the first i-f stage. Notice that the negative voltage on the base of the first transistor is slightly higher than the negative voltage on the emitter. We have .92 volt negative on the base and .76 volt negative on the emitter. This means that the base is negative with respect to the emitter. This is as it should be with a PNP transistor such as the type 2N409 used in this stage. You will remember that to forward-bias an emitter-base junction, we need a negative voltage on the base and a positive voltage on the emitter. Although both voltages shown on the diagram are negative with respect to ground, the emitter is positive with respect to the base.

When a signal is picked up and current flows through the diode CR1, the strength of the current flowing will depend upon the strength of the signal. If the signal

(Continued on page 4)

Index

Article	Page
Portable Receivers Using Transistors ..	2
Assembly and Use of a Volt-Ohmmeter in Kit Form	7
Hi-Fi Corner	12
The New NRI Professional Oscilloscope	16
NRI Alumni News, Chapter Chatter ..	18
The Essence of Leadership	25
In Memorium	29

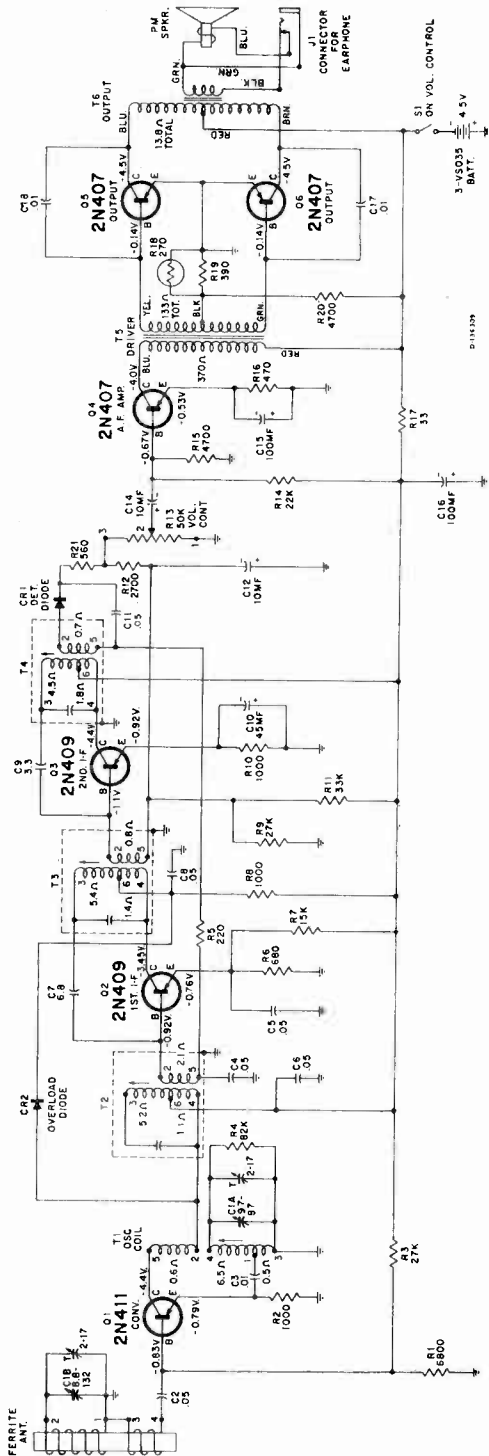

VOLTAGES MEASURED WITH "VOLTOHMVST" SHOULD HOLD WITHIN ±20% WITH NEW BATTERY. ALL CAPACITANCE VALUES LESS THAN 1.0 IN MF AND 1.0 & ABOVE IN MMF EXCEPT THOSE INDICATED.

TOTAL BATTERY CURRENT
 NO SIGNAL — 8.6 MA
 20 MW OUTPUT — 24 MA
 50 MW OUTPUT — 33 MA

TERMINAL CONNECTIONS FOR T2, T3 & T4

INDEX	02
DOT	6 0 0 5
	4 0 0 3

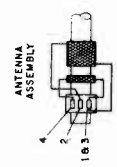
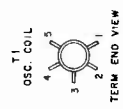

Figure 1. Diagram of RCA Victor "Jetstream" portable which uses six transistors and provides a separate earphone jack.

Portable Receivers Using Transistors

(Continued from page 3)

is strong, the current will be reasonably strong. This current, in flowing through the 680-ohm resistor R6 to get back to ground, will develop a voltage drop across it which will make the emitter end of the resistor negative. This will increase the negative voltage on the emitter, which will decrease the forward bias across the emitter-base junction. When this happens, the number of holes moving from the emitter through the base to the collector will decrease, and hence the collector current will decrease. When the collector current decreases, the voltage drop across the 1000-ohm resistor R8 will decrease. This means the negative voltage on the collector will increase, because this voltage is equal to the battery voltage minus the voltage drop across R8.

Now let's look at the overload diode CR2. One side of this diode is connected to the collector circuit of the converter stage, and terminal 4 of T2. The other side of it is connected to the junction of the 1000-ohm resistor R8, the .05-mfd capacitor C8, and terminal 6 of T3. This junction is held at signal ground potential by the .05-mfd capacitor C8. Terminal 6 of T2 is also at signal ground potential because it is by-passed by the .05-mfd capacitor C6, therefore the overload diode is effectively connected between terminals 4 and 6 of T-2.

This diode normally has a reverse bias on it so it does not conduct. This bias is due to the fact that the collector voltage on the converter is more negative than the collector voltage on the first i-f stage; therefore, the side of the diode CR2 that is connected to the converter circuit is negative, and the other side is positive; under these conditions the diode does not conduct. However, if a strong signal is picked up, we find that the current flowing through R6 changes the voltage on the emitter, which in turn changes the collector current in the first i-f stage. This causes the voltage across R8 to decrease, which makes the collector voltage increase. This means that the reverse bias on the overload diode decreases or may disappear entirely. When this happens, the overload diode conducts, and when it does, it loads the primary of T-2, reducing the Q and hence the signal developed across it. This will reduce the signal fed to the first i-f stage.

AVC voltage is also applied to the second i-f amplifier. The current flowing through the detector diode circuit must flow through the volume control and in doing so develops a voltage across the volume control, making terminal 3 positive. This voltage is fed through the 2700-ohm filter resistor R12 and the 10-mfd filter capacitor C12 back to the base of the second i-f transistor. The positive voltage drives the voltage on the base of this transistor in a positive direction, and hence reduces the forward emitter-base bias. This reduces the flow of holes from the emitter to the collector and hence the power gain in the transistor.

The audio signal across the part of the volume control between terminals 1 and 2 is fed between the base and emitter of the first audio amplifier. You will remember that the signal voltage will cause the emitter-base forward bias to vary, and this will cause a large variation in the number of holes crossing the emitter-base junction. This in turn will cause the number of holes reaching the collector to vary, and hence the electrons flowing through the external circuit to the collector will vary. This varying current will produce an amplified signal in the collector output circuit across the primary winding of the driver transformer T-5. The secondary winding of T5 is connected to two transistors which are used in a push-pull class B output stage. The output from these two transistors is combined in the output transformer T6 and fed to a loudspeaker.

You might wonder why a class B output stage is used in a portable receiver. The purpose is to reduce the current drain on the batteries. In a class A amplifier the tube or transistor is biased at the center of its characteristic curve so the current flows at all times. In the class B stage a tube or transistor is biased practically at cut-off and current flows through the tube or transistor only when the signal is applied to it. Thus in the class B output stage used in this receiver, there is very little current flow through the transistors until an audio signal is applied to them. Thus, the power consumed by the transistors is considerably less than it would be if they were used in a class A amplifier circuit where the same average current would flow at all times.

The circuits used in this receiver are typical of those that you will find in transistorized portable receivers. Some sets are

Following a good example is not always the wisest course of action—look what happens to a counterfeit.

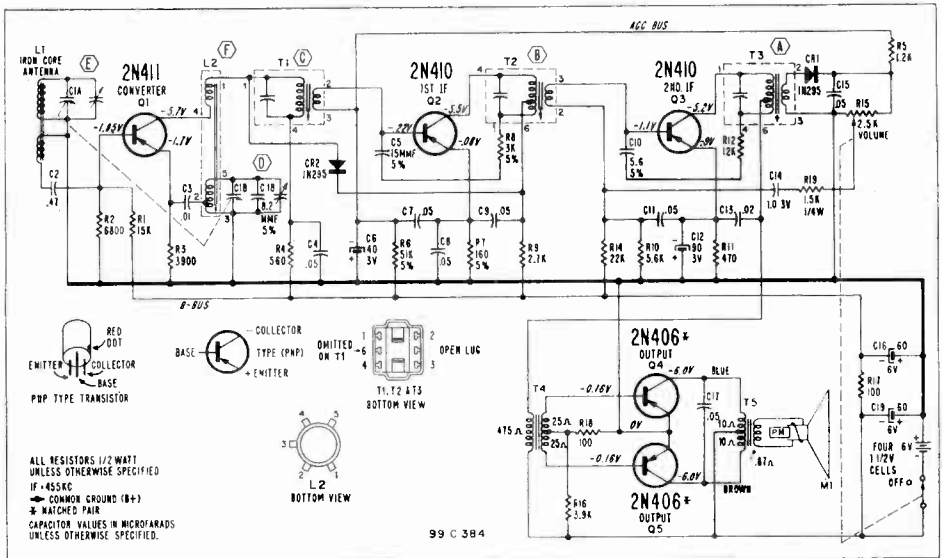

Diagram of Admiral superheterodyne using five transistors and two germanium diodes.

smaller than this and use fewer transistors. Some receivers have only a single i-f amplifier. Often in receivers with only a single i-f amplifier, specially selected transistors with a high gain are used in order to get enough sensitivity from the receiver.

Not all transistor portable receivers use a push-pull output stage. Some use a single-ended stage. Of course, the power output from a single-ended stage in a portable receiver is usually substantially less than the power output that is available from a push-pull stage. However, some portable receivers are very small and use speakers less than three inches in diameter. With small speakers of this type, you can't use a great deal of power anyway, because it would simply overload the speaker, and distortion would result. In these receivers a single-ended output stage is usually quite adequate.

In a single-ended stage, a driver transformer is not always used between the first audio stage and the output stage. Sometimes the stage is resistance-capacitance coupled. This arrangement usually is not quite as good as using a transformer, but it is more economical, so many manufacturers have adopted it.

Another circuit that has been used by some manufacturers is what is known as a reflex circuit. This is quite an interesting circuit, so let's look at a receiver using a reflex circuit.

A REFLEX PORTABLE

The basic idea in a reflex circuit is to make one stage do two jobs; usually in portable receivers, to make one of the amplifiers work both as an i-f amplifier and as an audio amplifier. The signal is fed through the i-f amplifier, and then it is fed to the detector. After the signal is detected, the audio signal is then fed back to the last i-f amplifier and amplified by it and then fed to the audio output stage. Because the signal is fed back in this way through the stage a second time, it is called a reflex circuit. You might at first think the signals would get mixed up, but remember, one signal is an i-f signal and the other an audio signal, so it is not too difficult to keep them separated.

A schematic diagram of a transistor receiver using a reflex circuit is shown in Fig. 2. Most of the circuits used in this receiver are not very different from those used in the receivers we discussed previously. The transistors are PNP transistors. Notice that there is an overload diode marked CR2. This diode is connected from terminal 1 of the input i-f transformer T1 to the terminal feeding the supply voltage to the collector circuit of the first i-f amplifier. Again, under normal conditions this diode has a reverse bias on it so it does not conduct. However, the avc voltage is fed through the 1.2K resistor R5 back to the secondary of T1, through the secondary to the base of the first i-f

(Continued on page 29)

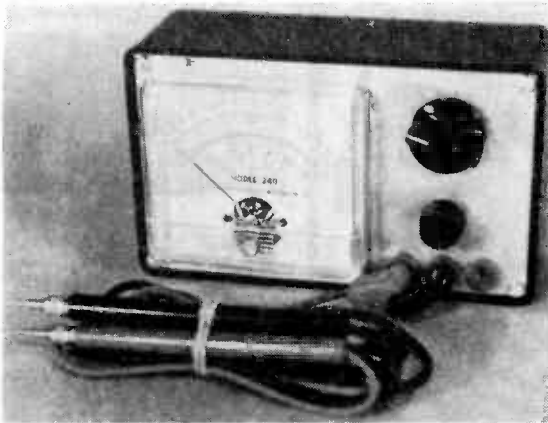

Fig. 1. A compact Volt-Ohmmeter That Can Be Assembled In One Evening.

Assembly and Use of a Volt Ohmmeter In Kit Form

By J. B. Straughn
Chief, Consultation Service

A prototype of a modern pocket size volt-ohmmeter kit is shown assembled in Fig. 1. We call this a prototype because at the time the picture was taken the finished front panel with etching identifying the switch and jack positions was not available.

This is a rugged, compact, and highly sensitive test instrument that should prove invaluable to both full-time and part-time Radio-TV technicians and hobbyists. Note the extended length of the meter scales and the simplicity of the controls. These make for speed and efficiency in using the instrument for circuit tests of all kinds.

Fig. 2 gives a view of the complete kit with the case removed. Note that all components, including batteries, fasten to the modern printed circuit board, which in turn is mounted on the front panel. The replacement of batteries can be accomplished in a matter of seconds.

The copper circuitry of the board which makes all the electrical connections between parts is shown in Fig. 3. This is before any parts have been mounted on the board. The copper side of a completed board is shown in Fig. 4. Pay particular attention to the strong but simple battery mounts and the amazing simplicity of assembly. The only wiring consists of several jumper wires from the battery mounts and the three-color coded leads from the copper oxide rectifier, visible from this angle. Also no wiring whatever is necessary on the coded index range switch. The switch lugs merely slip in the corresponding slots on the printed circuit board. This one feature completely eliminates one of the big-

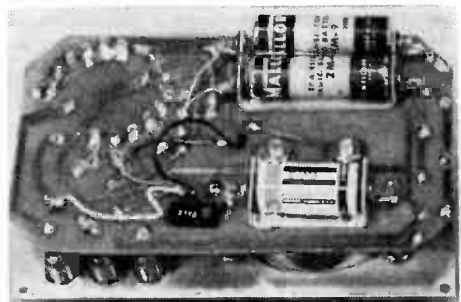

Fig. 2. Here you see the meter studs and switch contacts as they come through the board, the battery mounts, and the copper oxide rectifier. The resistors are on the other side of the board.

gest "headaches" (incorrect connections to the range switch) in a kit of this type. Notice also the easy access to the meter rectifier. This unit can be replaced, should the occasion ever arise, almost as quickly as the batteries. All connections are in view and no other components need be disturbed.

The assembly instructions showing the front side of the board on which the various resistors are mounted is seen in Fig. 5. The leads of all these resistors slip into holes in the printed circuit board and are soldered in place on the copper side of the board. No other wiring is necessary. These resistors are all put in place before the circuit board is permanently mounted on the panel.

Actually mounting parts on a printed circuit board is a source of real satisfaction. First, the resistor leads are scraped or lightly sanded so that there will be no

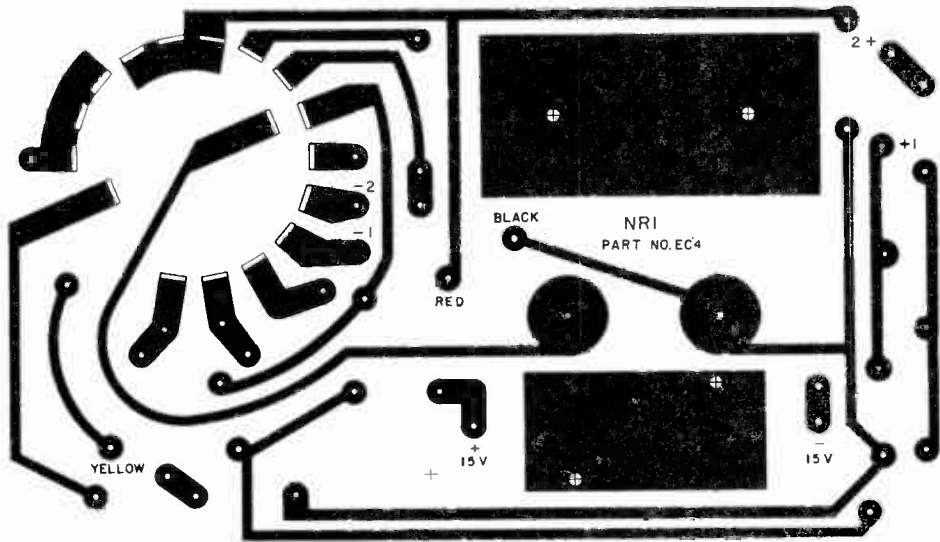

Fig. 3. Here you see the copper left on the board after it is etched at the factory. The two large rectangles are not an electrical part of the circuit. The battery containers are mounted on them. Holes for all parts are shown, but the holes for the meter studs that protrude through the round copper circles between the rectangles are much larger than indicated here. When the nuts are placed on the meter studs the meter is part of the circuit. The 17 switch lugs slip easily through the slots at the upper left corner of the board.

question of solder sticking to them readily. Then the leads are bent at right angles to the body of the resistor and the correct resistor leads slipped in the correct holes. Here you cannot make a mistake since you start at step 1 as shown in Fig. 5, and continue around the board in a clockwise di-

rection putting the resistors and the jumper in place, one at a time. In addition, the back of the board is marked with the correct resistor values. These markings of course cannot be seen in Fig. 5 since they are hidden by the resistors. When all the resistors are in place, you turn the board

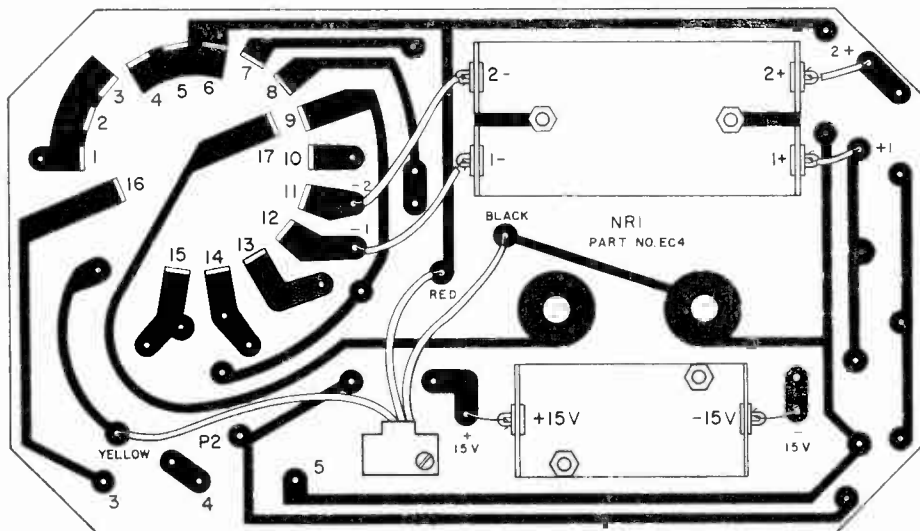

Fig. 4. Here we show how all parts are mounted on the back of the circuit board. The leads from the Ohmmeter Adjust and the jacks are put in later.

over and start soldering. For this purpose a pencil-type soldering iron is recommended, although a regular 60-watt iron can be used. Do not use a solder gun, because it keeps getting hotter and hotter as long as its trigger is depressed, and too much heat can damage the cement used to hold the copper to the board.

When soldering parts on a board, I put the soldering iron tip about one-quarter of an inch away from the board on the lead to be soldered. Then I melt about one-eighth inch of solder right at the iron tip and remove the solder roll. The rosin in the solder will run down the lead and begin to spread over the copper. When this occurs, the lead is hot enough to take solder and you just slide the iron tip down the lead until the tip touches the copper. At this time the solder will spread out around the lead and the iron tip is then removed. This same process is repeated for each connection. When all of the connections have been made, the leads are clipped off close to the solder with a pair of side cutters.

It may sound a little difficult to make connections in this manner, but experience will prove to you that it is the easiest kind of soldering. Recently I had occasion to construct ten large circuit boards for the NRI Model 250 scope. There were five sockets on each board and each socket had nine connections, making a total of forty-five connections per board. In all there were 450 connections. I timed myself and found that it took me one hour to install the sockets and solder all 450 connections. Actually the connections were soldered in forty-five minutes, which meant ten connections soldered per minute, or six seconds spent on each connection.

In view of this, you can realize how quickly this volt ohmmeter can be put together. Actually, anyone with a little experience in servicing and soldering should be able to do the complete job in one hour, or perhaps less.

A schematic of the circuit used is shown in Fig. 6, with the range switch in the 6vDC position. Here the common and DC jacks are used for the test leads. On the AC and Ohms ranges the red test lead plugs into the AC-OHMS jack, and the black lead into the COMMON jack. There are three DC voltage ranges, three AC voltage ranges, and three ohmmeter

ranges. These are:

O—6vDC O—6vAC O—1000w
 O—120vDC O—120vAC O—100,000w
 O—600vDC O—600vAC O—10,000,000w

The extended ohmmeter range of O—10 megohms is unusual in a pocket-sized instrument. Due to the need for an expensive meter and high voltage battery, most instruments of this type may measure only as high as 100,000 ohms. Thus, the instrument becomes more of a continuity tester and is incapable of measuring the resistors found in many radio and TV receivers. Although the highest marked value on this meter scale is 1K (10 megohms on the highest range) there is appreciable space between 1K and the infinity mark (∞) at the end of the ohmmeter scale. A meter reading halfway between 1K and ∞ can be readily seen and on the highest ohmmeter range represents a value of 20 megohms. Thus the ohmmeter becomes capable of checking any resistance value you will normally encounter.

The extended ohmmeter range is made possible by the use of 50-microampere meter and a 15-volt transistor type battery. This battery will have an extremely long life because of the low current drain, even when adjusting the ohms zero set (test leads held together).

The current drain on the 1.5 volt cell used to power the O—100,000 ohms range is also slight and this battery will have a normally long life.

It is the battery powering the O—1000 ohms range that takes a beating. When the test probes are held together to zero the meter on this range, a very high current is drawn from the battery. Essentially we have R_1 in Fig. 6 connected directly across the battery. Since this re-

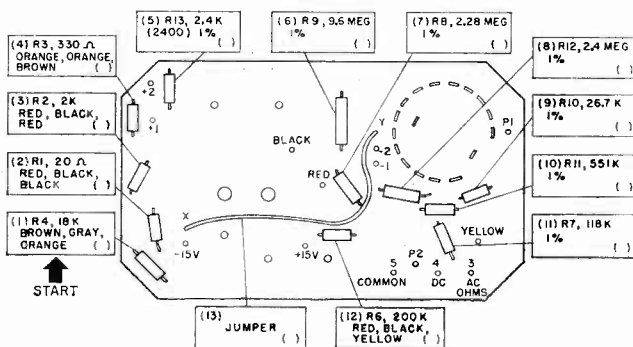

Fig. 5. Here all parts are mounted and the three batteries are ready to be slipped in place.

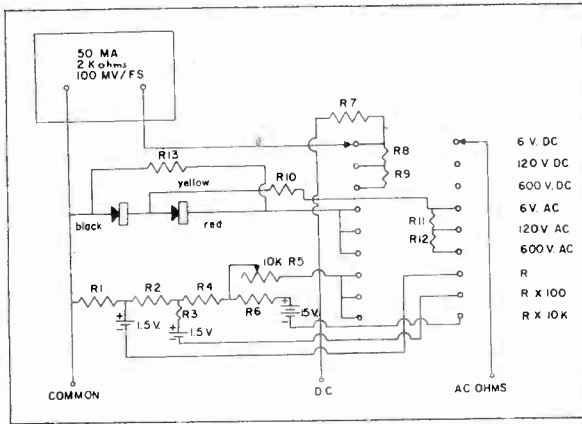

Fig. 6. Schematic diagram of the Volt-Ohmmeter. Notice that different jacks are used for DC and for AC-OHMS measurements.

sistor has a nominal resistance of 20 ohms, the current drain is $\frac{1.5}{20}$ or 75 milliamperes. This is true of all ohmmeters using this circuit (some draw even more) and in most cases results in a short battery life. Many times in using equipment of this type I have been hampered by inability to zero the ohmmeter due to run-down batteries. Of course 75 ma is not a high value of current but it's a lot to expect from a small penlite cell. If you have battery trouble with some other ohmmeter, don't use the low ohmmeter range unless you must measure a low resistance value. Don't be touching the test probes together, except when you zero the meter and make this adjustment without delay. For ordinary continuity testing use a higher ohmmeter range. These precautions will extend battery life considerably and should be used with battery-operated ohmmeters.

To avoid the short battery life you would normally expect, we decided to use 1.5-volt mercury cells rather than the ordinary 1.5 volt penlite cells. The mercury cells are relatively expensive, but in normal operation will outlast 10 of the penlite cells, and where the going is harder will do even better. In a pinch, penlite cells can be used to replace the mercury cells as they have the same physical size.

You might wonder why the highest voltage range is 600 volts when so many pocket meters are advertised as measuring 1500 volts, or even 5000 volts. The answer is simple. You won't find more than 600 volts to measure in a receiver unless you wish to check the 12,000 to 18,000 volts on the picture tube anode of a TV set. The extended range of 1500 or even 5000 volts found on some instruments is, of course,

worthless for such a measurement, so why clutter up a meter scale with ranges you will never use just for advertising purposes? With a special high-voltage probe, the instrument shown in Fig. 6 can be used to check picture tube anode voltages, even in color sets which may run as high as 25,000 volts or more.

With the 50-microampere meter, the instrument has a dc sensitivity of 20,000 ohms-per-volt. This is standard in all high grade volt-ohmmeters. If you are considering an instrument where the ohms-per-volt rating is not given, beware—it is probably on the order of 1000 ohms-per-volt and therefore practically worthless in servicing modern equipment. This does not apply to VTVM's which are judged by their input resistance and which cannot be rated as having so many ohms-per-volt.

Just what does "ohms-per-volt" mean? It tells you the resistance of each range of the voltmeter. On the 600-volt range, for example, the meter resistance is $600 \times 20,000$, or 12,000,000 ohms. The exact reading you obtain when using this range makes no difference—the meter resistance for this range is 12 megs, which compares favorably with good VTVM's.

On the 120-volt range, the meter resistance is $120 \times 20,000$, or 2,400,000 ohms, while on the 6-volt range the meter resistance drops to $6 \times 20,000$, or 120,000 ohms.

Remember, whatever you connect across a

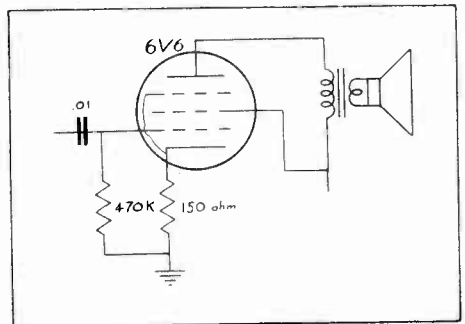

Fig. 7. To measure the true grid bias, check the voltage across the 150-ohm cathode resistor. The control grid of the tube should be at ground potential as far as dc is concerned. A dc voltage across the grid resistor indicates a gassy tube or a leaky coupling capacitor, or both.

circuit becomes a part of the circuit under test. I had this driven home to me very forcibly years ago when I was servicing a dead receiver. The set would play whenever I measured the cathode-to-chassis voltage of a certain tube. It took a little time for me to figure that one out, but I didn't seriously think of selling the customer the cheap voltmeter (400 ohms per volt) I was using. It finally dawned on me that there was an open cathode resistor and that the resistance of the meter was just about right to complete the circuit and give normal operation. Yes, whatever you connect to a circuit becomes a part of the circuit.

The importance of using a meter with a high ohms-per-volt rating becomes apparent in making measurements in high resistance circuits. If the meter resistance is many times that of the circuit across which it is connected, then connecting the meter causes little change in the circuit resistance and you measure the normal circuit voltage. Take, for example, the circuit shown in Fig. 7. If you use the 6-volt range of the meter and connect from cathode to ground, you are placing 120,000 ohms (the meter resistance) in parallel with the 150-ohm cathode resistor. For all practical purposes the cathode-to-ground resistance is still 150 ohms and your meter will measure the true cathode-to-ground voltage.

On the other hand, if you connect your meter from the control grid to cathode you have a 470K resistor in series with the meter and the voltage will divide between the grid resistor and the meter, giving a reading considerably less than the true control grid-to-cathode voltage. However, you will read a much higher voltage than you would if you had a 1000 ohms-per-volt meter (6000 ohms on the 6-volt range).

Servicemen don't stop and figure out the expected results when they make a voltage measurement in a high resistance circuit. If they did, few sets would ever get fixed. They do, however, have in the back of their minds that when they touch their meter probes to a circuit the meter becomes part of the circuit. Receiver manufacturers take into account the meter resistance when giving voltage measurements. Generally they use a standard 20,000 ohms-per-volt voltmeter, and the published voltage values are the same as those you will obtain when using an instrument with the same sensitivity.

With practice you will soon know what to expect from your instrument in various circuits and will never give its resistance another thought unless you find a set that

won't work unless your meter is connected to it.

On AC the meter resistance is ordinarily of little importance because most measurements are made in very low resistance circuits—a few ohms or so. Because of the shunting effect of the copper oxide rectifier in Fig. 6 the AC meter resistance is about 5000 ohms-per-volt, but this is entirely adequate for all service purposes. There are, however, cases where a relatively high meter resistance such as 5000 ohms-per-volt or more is valuable for AC measurements. It is frequently necessary to make voltage measurements of signal voltages in TV oscillator circuits. With a low ac sensitivity, serious circuit disturbance would probably result. The instrument described here has an input resistance of about 45,000 ohms on the 6-volt ac range, and progressively higher input resistances on the upper ranges. This is a very desirable feature in any testing instrument, whether a portable instrument or a bench type.

You will notice that there are no DB scales on this meter. They were purposely left off as being worthless to a serviceman, and because they would only clutter up the scale, making it more difficult to read the scales in which you are interested.

There are no provisions for measuring current because servicemen practically never make current measurements. To measure current you must open the circuit, insert the meter, read it, remove the meter, and resolder the circuit.



To the average serviceman this is a waste of valuable time, and there is always the possibility the circuit is defective or that your meter probe will slip with a burned-out meter as a result.

Suppose in Fig. 7 you wanted to know the cathode current of the tube. You can find it quickly by measuring the voltage across the cathode resistor, and by dividing the voltage by the resistance. Suppose you measure 15 volts. Just divide 15 by 150 ($15 \div 150 = .1$) and you find that .1 amp or 100 ma is flowing through the circuit. This is an abnormally high current, so you try another tube to see if the first one was gassy. If a new tube also has excess current, you see if there is a dc voltage across the 470K grid resistor. Normally there is no dc voltage across this resistor. If there is, you clip one lead of the .01 mfd coupling capacitor. If this causes the voltage across the 470K resistor to disappear, the capacitor was leaky. This means that a +DC voltage was being applied to the control grid of the 6V6 tube from the B supply of the tube in the previous stage (not shown) through the leaky coupling capacitor.

All in all, a small pocket volt ohmmeter is a mighty handy test instrument. It is especially valuable on service calls because it takes up so little room, and because, unlike a VTVM, you don't have to plug it into the power line and wait for it to heat up. An instrument such as this is ready to go at all times and should be a part of every serviceman's traveling equipment.

— n r i —

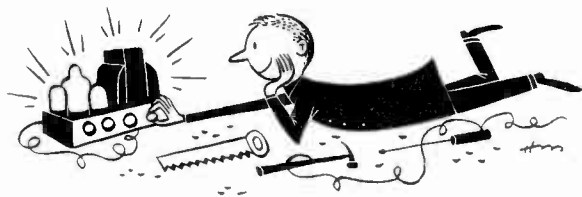

Component vs. Package Hi-Fi

Q. What do you mean by "Component" and "Package"?

A. A component type high fidelity system is one in which the individual units (amplifiers, speakers, etc.) made by different manufacturers are chosen by the consumer and interconnected to form a complete system.

Package systems, as the name implies, are

Page Twelve

It Can Be Done

Somebody said that it couldn't be done,
But he with a chuckle replied,
That "maybe it couldn't" but he would
be one
Who wouldn't say so till he'd tried.
So he buckled right in with the trace of
a grin
On his face. If he worried, he hid it.
He started to sing as he tackled the thing
That couldn't be done. And he did it.

Somebody scoffed: "Oh, you'll never do
that,
At least no one ever has done it."
But he took off his coat and took off his
hat
And the first thing he knew he'd begun it.

With the lift of his chin and a bit of a grin,
If any doubt rose he forbid it;
He started to sing as he tackled the thing
That couldn't be done, and he did it.

There are thousands to tell you it cannot
be done,
There are thousands to prophesy failure;
There are thousands to point out to you,
one by one,
The dangers that wait to assail you,
But just buckle right in with a bit of
a grin,
Then take off your coat and get to it.
Just start in to sing as you tackle the thing
That cannot be done, and you'll do it.
Author Unknown

— n r i —

Hi-Fi Corner

by John G. Dodgson

complete systems assembled and sold by one manufacturer in one or two furniture-type cabinets.

Q. Which sounds better?

A. Dollar for dollar, the component system.

Q. Ignoring cost, which sounds better?

A. The component system, but you can't ignore cost. After all, that's the first consideration when most people decide to purchase Hi-Fi.

Q. Then why are so many "Package" systems sold?

A. For several reasons. Primarily, the availability. Package Hi-Fi can be bought at almost all furniture, department, appliance, and even some hardware stores. Remember that the public is used to buying their radios, TV's, and phonographs at these stores, so why not Hi-Fi? Second, most people are unaware of the vast difference between package and component high fidelity. Some who know there is a difference don't know enough about it to choose and interconnect their own components and are afraid to trust a salesman. Third, and this is most important, a great number of people, especially women (who are the great buyers in America) are more concerned with the beauty of the furniture than the beauty of the sound. Another big reason is "brand name." Bogen may be an old reputable name in audio but it sure isn't in the housewife's vocabulary. Because of this, the housewife will buy a "Magnificent Mushroom Super High Fidelity." After all her mother bought "Mushmouth" radios, she buys "Mushmouth" TV, so why not "Mushmouth Hi-Fi?"

Q. Then Package Hi-Fi is just a waste of money?

A. No, not at all. Just remember that a good chunk of the cash involved in the transaction is going into the quality of the furniture and not the quality of the sound. If the purchaser is as much or more concerned with the appearance of the cabinet as he is with the sound then he isn't wasting his money. But if he's more concerned with the quality of the sound he may be bilked by the appearance, name, or "advertising" specifications.

Q. If Package Hi-Fi is so bad, why does it sound good to most people?

A. Because it is good—compared to what the public is used to: table radios, TV sets, etc. A medium-priced modern package Hi-Fi is considerably better than these familiar sets as well as the best of the non-Hi-Fi commercial phonographs or juke boxes. However, if it were possible to compare a package Hi-Fi with a component type in the same price range, the difference in quality would be just as evident.

Q. Why is the component type Hi-Fi so superior?

A. Because the individual components—cartridge, turntable, amplifier and particularly the speaker and enclosure—are superior in themselves.

Q. Specifically, what is so different about the units?

A. Well, let's look first at what is probably the most important and unfortunately usually the greatest difference—the loudspeaker and enclosures. Component systems use what we call high-fidelity speakers. These are precise units specifically designed and built for wide-range reproduction with special cone materials,



magnetic structures, and very low tolerances. In addition to wide frequency response, they are especially characterized by smooth response and low distortion.

Package units, on the other hand, almost always use replacement or public address type speakers. As you might expect, this type speaker has very ragged response and high distortion. To make up for the lack of bass response and power handling ability, usually several speakers are used.

Q. Now wait a minute! First of all, I've seen some of these "package" speakers stamped "High Fidelity" and, in the second place, what is wrong with using more than one speaker?

A. Well, the Hi-Fi stamp on the speaker is like chrome on a car. It doesn't make it work better but it sure does increase the price! Speaking of chrome, one package manufacturer actually does chrome-plate his speaker frames, transformer cases, chassis and most everything else made of metal. Others are content to merely paint the speaker frames gold or stamp them "Hi-Fi".

To get to your second objection, there's nothing wrong with using two or three or even more speakers but it shouldn't be necessary. One good speaker can outperform a half-dozen poor ones. When you see a particular Hi-Fi package advertised as featuring a large number of speakers, you can be sure that they're

pretty poor speakers. It would be far better for the manufacturer to replace the half dozen poor speakers with one or two good ones.

Q. Well, why doesn't he?

A. Cost is probably the most important factor. But the package Hi-Fi manufacturers also got themselves caught up in a "speaker-number" race like Detroit's horsepower race. The public has come to accept the fallacy that the number of speakers determines the quality. In fact, the first time non-technical personal friends hear my Hi-Fi system (component, naturally) their first question is invariably "How many speakers?" The answer of "two" is quite a surprise to them.

Q. So! You use more than one speaker!

A. Yes, the large 12" speaker is used to reproduce the low and mid-frequencies from its low limit of 30 cps to 3,500 cps where a crossover network divides the sound and feeds the "highs" to a tweeter. This is a common arrangement for component systems. In fact, some divide the frequency spectrum two or three times and each speaker then reproduces only a portion of the total sound. Let me repeat—it is the quality of the speakers that count—not the number.

Q. You mentioned enclosures; what do you mean?

A. A speaker enclosure is the cabinet housing the speaker which is acoustically designed to enhance the speaker's characteristics.

Q. Wow! But so what! Package systems inherently have cabinets.

A. Yes, but they're not designed for speakers. They're usually designed for appearance and to house the amplifier and record-changer. Any room that happens to be left over is given to the speakers. Usually, the back and bottom of the cabinet are left open.

Q. So how important is the cabinet?

A. Strangely enough, the enclosure design is just as important as the speaker design. For example, a good 8-inch high fidelity speaker in a properly designed enclosure can usually outperform four or five larger (non-high-fidelity) speakers in an open back cabinet.

Q. What about the other parts in the system?

A. Again just about the same thing said about the speakers can be repeated. Generally inexpensive record changers, replacement type cartridges.

Q. Wait a minute! Replacement type cartridges?

A. Yes, we call them "replacement" because they're produced for servicemen to use as replacements for older defective cartridges. Remember that these "blue-ribbon" replacements are infinitely better than the best crystal pick-ups of just a few years ago. Of course, they do not have the quality of the magnetic cartridges used in component systems.

Q. O.K., what about the amplifier?

A. The amplifiers are pretty fair—about equal to a high-quality, low-power public address unit. Their biggest fault is in the output transformer. This is the most important part of the amplifier and, as you might expect, it is expensive. One incidental point about the amplifiers is that they are usually overrated powerwise.

Q. You mean they put out less power than the manufacturer says they will?

A. Yes, but exaggerated advertising is pretty common for all products today, isn't it? Most low and medium cost amplifiers use 6V6 or equivalent type power output tubes. These particular tubes are capable of 12 watts (with tolerable distortion) yet I've seen amplifiers using these tubes rated at 15 to 20 watts.

Q. How much power is needed?

A. That depends on several factors — principally the room size and speaker efficiency. My speaker system is about 20% to 30% efficient while an open-back package system cabinet with two or three 12" speakers might be 5% to 10% efficient. Now if we take an average of 25% for my system and 7% for the "package," I need 1/3 less power or, conversely, the "package" requires three times more power than I to produce the same loudness in the same room. In actual tests, the average power fed to my speaker is 1/5 watt while the peaks reach as much as ten times this.

Q. Is efficiency then equal to quality?

A. No, not at all. In fact, there are a number of high quality speaker systems that are only 1% to 2% efficient.

Q. What, then, are the obvious noticeable differences between component and package systems?

A. Well, first of all, with the higher quality units in the component system there will be less break-down and need for repair. This saves money in the long run. Another money-saver is on records.

Q. How so?

A. Package systems always use record changers and changers are records' worst enemies. The center-post wears the center hole larger, the records drop on each other and mar the surfaces, but worst of all the stylus (or needle) pressure is very high and almost doubles as records stack up on the table. This soon wipes out the high frequencies.

Q. What about the "listenable" differences?

A. The all-important mid-range in a component system will be smooth and clean. Package sound is generally "ragged" here. However, the main difference is at the ends of the frequency range.

Q. Wait a minute, what do you mean by "ragged"?

A. Well, when a musical instrument is struck or blown, it produces a sound. This sound is composed of a certain fundamental frequency plus overtones or harmonics. These fundamentals and harmonics have a definite amplitude (or loudness) relationship to each other. For example, if The key of A (440 cps) on a piano is struck, the second harmonic, 880 cps, might be half as loud as the fundamental and the third harmonic, 1320 cps (3 x 440) might be only one-tenth as loud. A violin produces harmonics with different amplitudes—which is why its sounds different from a piano. At any rate, no matter what instrument is played, it's the job of the speaker to put out the sound in the correct relationship and this is where poor speakers fall down. Instead of producing the second harmonic at, say, 50% of the fundamental amplitude, it might produce it at 10%. Then, it might produce the third harmonic at 60% instead of 10%. As a result, the harmonics would have improper relationship and resultant sound would be ragged. That's about the best description!

Q. What about the high end?

A. It isn't too difficult or expensive to produce a high-frequency speaker or tweeter that will produce sound out to 15,000, or 20,000 cps but it's extremely difficult and expensive to make a tweeter produce smooth sound (even response) at these high frequencies.

Q. I know, I know, "package" tweeters are ragged!

A. You're so right; but things are even worse at the low end.

Q. How so?

A. The low frequencies are the most difficult ones to produce and, naturally, the bass from a package system is less "true sound" than at any other portion of the frequency spectrum.

Q. I don't know about that. I've heard some bass drums played on package systems that really come through with a whooping boom!

A. You hit the nail right on the head! Bass-drums don't "boom"—they "thump." It should sound like a rug being beaten not like a gong! The next time you get a chance at a dance or band concert stand near the drum when it is hit. You'll find out that you can "feel" the sound more than you can hear it—something like someone pushing in on your chest. You'll hear something too, a sharp, short, and very "dead" thump.

That "whopping boom" sound you heard was composed of about 10% to 20% of the true bass-drum sound and 80% to 90% of the higher harmonics. This is what we call "doubling" because most of the speaker output is double (and very often triple) the signal fundamental frequency.

Q. 80% to 90% seems pretty high!

A. Yes it is—that means the speaker is producing 80% to 90% second harmonic distortion. This is quite normal for inexpensive speaker systems. Even the best often have as much as 10% distortion at 50 or 60 cps.

Q. In other words, most of the bass output of package systems is not true sound but mostly distortion?

A. Quite true. The distortion usually becomes prominent at about 200 cps and increases appreciably as the frequency decreases. Very often, except in the most expensive "packages," the output below 100 cps is mostly second and third harmonic distortion instead of fundamental response.

Q. Well, doesn't this happen in "component" systems, too?

A. Yes, it does, but to a lesser extent since the speakers are designed to produce smooth sound.
(Continued on page 24)

STATEMENT REQUIRED BY THE ACT OF AUGUST 24, 1912, AS AMENDED BY THE ACTS OF MARCH 3, 1933, AND JULY 2, 1946 (Title 39, United States Code, Section 233) SHOWING THE OWNERSHIP, MANAGEMENT AND CIRCULATION OF

NRI News, published bimonthly at Washington, D. C., for October 1, 1958.

1. The names and addresses of the publisher, editor, managing editor, and business managers are:

Publisher, National Radio Institute, 3939 Wisconsin Ave., N. W., Washington 16, D. C.
Editor, Theodore E. Rose, 3939 Wisconsin Ave., N. W., Washington 16, D. C.
Managing editor, None.
Business manager, None.

2. The owner is: (If owned by a corporation, its name and address must be stated and also immediately thereunder the names and addresses of stockholders owning or holding 1 percent or more of total amount of stock. If not owned by a corporation, the names and addresses of the individual owners must be given. If owned by a partnership or other unincorporated firm, its name and address, as well as that of each individual member, must be given.)

Edward L. Degener, 5609 Midwood Rd., Bethesda, Md.

Elsie Smith Davis, RFD 1, Rochester, New Hampshire.

The National Radio Institute Charitable Trust, c/o J. E. Smith, RFD 1, Box 228, McLean, Va.

Carol Smith Galbraith, Michael Morrison Galbraith, Gall Alexandra Galbraith, 430 E. Ledbetter Drive, Dallas 16, Texas.

James E. Smith, Sarah Morrison Smith, RFD 1, Box 228, McLean, Va.

Emma Smith Stuart, 2108-A San Miguel Canyon Rd., Sallnas, Calif.

James Morrison Smith, Susan Morrison Smith, Lee Morrison Smith, James Morrison Smith, Jr., Terry Morrison Smith, RFD 1, Box 181, McLean, Va.

Marjory M. S. Sarich, Charles B. Sarich, James R. Sarich, RFD 1, Box 229, McLean, Va.

David H. Smith, RFD 1, Rochester, New Hampshire.

3. The known bondholders, mortgagees, and other security holders owning or holding 1 per cent or more of total amount of bonds, mortgages, or other securities are: (If there are none, so state.) None.

4. Paragraphs 2 and 3 include, in cases where the stockholder or security holder appears upon the books of the company as trustee or in any other fiduciary relation, the name of the person or corporation for whom such trustee is acting; also the statements in the two paragraphs show the affiant's full knowledge and belief as to the circumstances and conditions under which stockholders and security holders who do not appear upon the books of the company as trustees, hold stock and securities in a capacity other than that of a bona fide owner.

5. The average number of copies of each issue of this publication sold or distributed through the mails or otherwise, to paid subscribers during the 12 months preceding the date shown above was: (This information is required from daily, weekly, semi-weekly and triweekly newspapers only.)

NATIONAL RADIO INSTITUTE
E. L. Degener, General Manager

Sworn to and subscribed before me this 13th day of October, 1958.

Charles Alexander, Notary Public

(My commission expires January 14, 1959.)

**New NRI Professional
Wide-Band TV Oscilloscope Kit**
for servicing black-white and color TV receivers, AM-FM Radios, hi-fi amplifiers, industrial Electronics equipment.

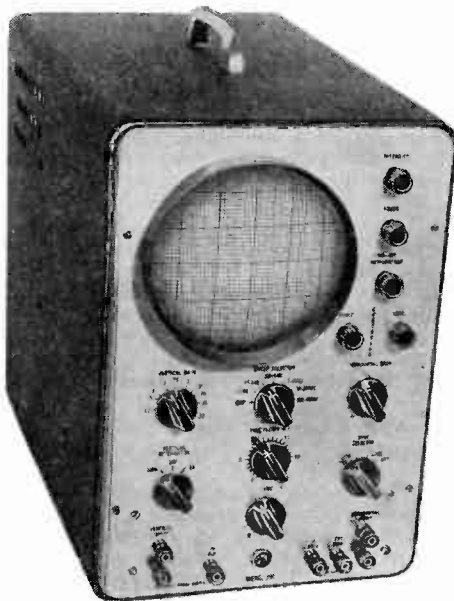

NRI DESIGNED for your complete satisfaction. For color, black-white TV servicing; AM-FM and transistor radios; high fidelity; industrial Electronics.

HIGH SENSITIVITY—.023 (RMS) volts per inch; but not noisy.

READ PEAK-TO-PEAK VOLTAGES directly. No calculations required.

RUGGED CONSTRUCTION; built to last. Truly professional appearance.

WIDE BAND RESPONSE. No wave distortion transients. Actually shows 3.58 color burst.

USES PHASE INVERTER TUBES in horizontal and vertical push-pull output stages.

SYNCS AND LOCKS EASILY—with positive action—on any TV receiver signal. Traces TV signals; locates defective sync circuits.

ACCURATELY MEASURES RIPPLE OUTPUT of any power supply. Check auto radio vibrators dynamically.

VERTICAL AMP RESPONSE—flat 13 cps to 2.5 mc down 1.5 db at 3.58 mc.

SWEEP RANGE—10 cycles to 500 kc. Uses special NRI linearity circuit.

PLENTY OF BRIGHTNESS. No need to turn off or dim lights to see trace.

PERFECT FOR SQUARE WAVE ANALYSIS and FM-TV alignment with a sweep generator.

QUALITY COMPONENTS THROUGHOUT. Standard 90-day EIA parts and labor warranty.

AVAILABLE ON LOW MONTHLY TERMS.

Uses two printed circuits, clear instructions, easy to build.

ADVANCED DESIGN—NEW CIRCUITRY

NRI ENGINEERS worked more than a year perfecting the design of the Model 250. We were not content to produce just another Oscilloscope kit; a copy of a manufactured model or duplicate of some other kit. The field of service type Oscilloscopes was thoroughly investigated and many scopes were tried out in actual service work.

We found shortcomings; objectionable features, and corrected them in designing the Model 250. Here are just a few:

1. Most scope traces are dim; some nearly disappear under normal bench lighting when sweep frequency, vertical gain or horiz. gain is increased. This is caused by a reduced CRT voltage of 1500 volts or less. Less expensive to build.

NRI solved this in the Model 250 by increasing CRT voltage to 2400 volts and designing our own new vertical and horizontal amplifiers. Result—plenty of brightness. Trace will not disappear.

2. Measuring peak-to-peak voltages with most scopes can be a cumbersome, time-consuming process. View the wave shape, remove probes, feed in calibrating signal, adjust vert. gain, reconnect probes and adjust attenuator.

NRI made simplicity the keynote here by calibrating the vertical gain control for direct readings of peak-to-peak voltages.

3. On some service scopes, retrace lines often show and confuse the display at high sweep frequencies.

NRI corrected this in the Model 250 by using a two stage retrace blanking amplifier which gives 100% retrace blanking at all frequencies produced by the scope sweep generator.

ADDITIONAL SPECIFICATIONS

Vertical sensitivity: .023 VRMS after internal calibration is adjusted.
 Frequency response: Flat from 13 CPS to 2.5 mc. Down .05DB at 11 CPS. Down 1.5 DB at 3.58 mc. Down 3.5 DB at 4.5 mc.
 Horizontal sensitivity: 1.0 VRS.
 Frequency response: Flat from 20 CPS to 90 kc. Down .8 DB at 12 CPS. Down 3 DB at 250 kc.
 Uses 11 tubes including dual types giving equivalent of 19.
 Rise time: .05 ms.
 Sweep frequency: 10 CPS to 500 kc.
 Push-Pull on-off switch.
 Operates from 110-120 volts, 60 cycle only.

IMPRESSIVE CABINET AND PANEL

Sturdy aluminum cabinet finished in handsome black wrinkle. Dimensions 9 $\frac{3}{4}$ " x 13 $\frac{1}{2}$ " x 15 $\frac{1}{2}$ ". Brushed aluminum panel with deep etched black lettering. Red and black control knobs, "5-way" binding posts. Strong carrying handle and rubber feet on bottom of cabinet to prevent marring. Added features that give you professional appearance and operation. Overall shipping weight, 23 lbs.



PROFESSIONAL PROBE SET AVAILABLE AT EXTRA COST

Even though most scope observations and tests can be made with ordinary test leads, special probes are necessary to get maximum use from this instrument.

This DeLux Probe Set, designed for use with the Model 250, includes complete instructions, sturdy roll-up carrying case, shielded cable and these probes. 1. High impedance, low capacity probe. 2. Crystal demodulator probe. 3. Resistive isolating probe and 4. Shielded direct probe. Price complete—only \$14.95.

USE THIS BLANK TO ORDER YOUR MODEL 250 OSCILLOSCOPE KIT

NATIONAL RADIO INSTITUTE
 3939 Wisconsin Ave.
 Washington 16, D. C.

Also available fully assembled. Write for details.

I enclose \$..... (money order, bank draft or check) for which send me the equipment I have indicated below. I understand shipment will be by Express, charges collect on delivery.

One NRI Professional Model 250 Oscilloscope Kit with assembly and instruction manual \$89.50
 One Set of Four Oscilloscope Probes \$14.95

If you live in Washington, D. C., add 2% D. C. Sales Tax.

Total amount enclosed

Tell me how I can buy this instrument on monthly terms.

Name Stu. No.

Address

City Zone State

Express Office

(Please print name and address)

NRI ALUMNI NEWS

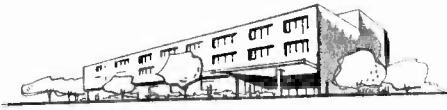

Howard Smith	President
F. Earl Oliver	Vice President
Jules Cohen	Vice President
William Fox	Vice President
Joseph Stocker	Vice President
Theodore E. Rose	Executive Sect.

Chapter Chatter

NEW ORLEANS CHAPTER'S Gaston Galjour delivered a fine talk on AGC circuits which was very well received by the members.

The Chapter devoted its December meeting to its TV clinic, during which former chairman Pat Boudreaux was the principal speaker, and to election of the officers to serve in 1959. The successful candidates were: Herman Blackford, Chairman; Louis Grossman, Secretary; and Octave Jumonville, Jr., Treasurer.

The members have decided to take up a detailed discussion and study of color TV at the Chapter meetings—a subject which is becoming increasingly important to Radio-TV servicemen.

NRI students and graduates in the New Orleans area who are not attending these meetings should make it a point to do so for the valuable practical help they can get with their Radio-TV problems. Those interested should get in touch with Secretary Louis Grossman, 2229 Napoleon Ave., New Orleans. The meetings are held at 8:00 p.m. on the second Tuesday of each month at Secretary Grossman's home.

PHILADELPHIA-CAMDEN CHAPTER reports its slate of officers to serve for 1959 as follows:

Chairman, John Pirrung; Vice-Chairman, Fred Seganti; Rec. Sec'y, Jules Cohen; Fin. Sec'y., Joe Burke; Treasurer, Charles Fehn; Librarian, Charles Wells; and Sergeant at Arms, Herbert Enrich.

The first five officers are carry-overs from 1958. The last two are new officers elected to serve their first term.

A great many new members joined the Chapter during 1958. The latest were Bernard Ebba, Phila.; Anthony Gabriel, Woodlyne, N. J.; Terence J. Gormley, Phila.; Joseph Miller, Phila.; and Henry Ciavola, Phila. As a matter of interest, Terence Gormley is an old-timer who was formerly a member of the Chapter about twenty years ago. The Chapter is particu-



Fred Seganti and Harvey Morris of the Philadelphia-Camden Chapter, to whom the chapter is indebted for their excellent talks and demonstration at its meetings.

larly glad to have him back again. A hearty welcome to all these new members!

Plans have been made to have Henry Lapinski of the Hot Point Company as a guest speaker in February, and in March the members expect to make another tour of the Philadelphia Police Radio Centre. This is a newer and larger Radio Centre. The more recent members who did not visit it on the Chapter's last trip will make it this time.



Officers of the Philadelphia-Camden Chapter. Front row: John Pirrung, Joe Burke, Fred Seganti. Back row: Chas. Wells, Herbert Enrich, Jules Cohen. Jules Cohen is also a Vice-President of the NRI Alumni Association,

Plans are also going ahead for the Chapter's Twenty-Fifth Anniversary Party to be held in May and all the members are looking forward to this important event.

A warm welcome awaits any NRI student or graduate who wishes to attend the chapter's meetings either as a guest or as a prospective member. Those interested should get in touch with Secretary Jules Cohen, 7124 Souder Street, Phila. The meetings are held at 8:00 P.M. on the second and fourth Monday of each month at the Knights of Columbus Hall, Tulip and Tyson Streets, Phila.

BALTIMORE CHAPTER wishes to salute Mr. James Magnusson, a relatively new member, on the very extensive knowledge of electronics that he possesses. Individuals with his background are regarded as valuable assets to any local chapter of the NRI Alumni Association, since they can be of great assistance not only in chapter activities but to the membership as well.

Elmer Shue is still working on his electronic theremin and he expects soon to bring it to a meeting for a demonstration. There are many kinds of music but the kind that Elmer plays is distinctively his very own. Chapter members, recalling his earlier electronic banjo performance, are looking forward eagerly to this event.

All NRI students and graduates in the Baltimore area are cordially invited to the meetings, which are held at 8:00 P.M. on the second Tuesday of each month at 100 N. Paca St., Baltimore. For more information about the meetings and the chapter's activities, get in touch with Chairman Joseph Dolivka, 717 N. Montford Ave., or Secretary John Woolschleger, 1106 S. Lakewood Ave., Baltimore.

NEW YORK CITY CHAPTER enjoyed real growth in 1958. Not only did the chapter sign up a great many new members but attendance at the meetings broke all previous records. The members feel justly proud of this accomplishment, and well they may.

Throughout the year, at practically every meeting, there were very interesting discussions and lectures by various members on all phases of Radio and Television work. These talks are a great help to the members in locating trouble and repairing receivers.

The chapter's Annual Party was an unqualified success. It was attended by 52 members and four guests, including Ted Rose, Executive Secretary of the NRI Alumni Association, and J. B. Straughn of the NRI Staff. The feature of the eve-



Chairman McAdams addressing the members at New York City Chapter's Annual Party. Seated l to r: J. B. Straughn, Ted Rose and Frank Zimmer.

ning was a lecture by Mr. Straughn on the new NRI Model 250 Five-Inch Oscilloscope. With the assistance of Tom Hull Mr. Straughn gave a demonstration of this scope during which he used the chapter's seven-inch TV receiver. Ted Rose administered the oath of office to Willie Fox who was re-elected as a Vice-President of the NRI Alumni Association for 1959. There was plenty to eat (including that wonderful potato salad so generously provided by Mrs. McAdams) and to drink, and everyone obviously enjoyed the party. Pictures were taken by Dave Spitzer, Willie Fox and other "shutter bugs."

At subsequent meetings Onte Crowe delivered a talk on and displayed his voltage booster and isolation transformer and how they work. He could not demonstrate his inter-com set as the chapter's RCA set was not working in coordination with the intercom, so this particular part of the



Willie Fox signing oath of office as Vice-President of NRIAA for 1959, just after being sworn in by Ted Rose at right. Seated, Frank Catalana.

demonstration was postponed for another meeting. Frank Catalano related some of his TV experiences; Ed McAdams told about the trouble he had in his own TV set and that he had lost the picture completely; and the always-interesting Jim Eaddy spoke about a portable set with which he had vertical trouble and of his experience with an automobile radio.

All of the chapter's officers for 1958 were unanimously re-elected to office for 1959. They are: Ed McAdams, Chairman; Tom Hull, Executive Chairman; Frank Zimmer, First Vice-Chairman; Emil Ruocco, Second Vice-Chairman; David Spitzer, Secretary; Frank Catalano, Treasurer; and Peter Sales, Librarian.

The chapter urges all NRI students and graduates in the area to come to its meetings, either as guests or prospective members. The chapter meets on the first and third Thursday of each month, 8:30 P.M., at the St. Marks Community Center, 12 St. Marks Place, New York City. For more information about the meetings get in touch with Chairman Edward McAdams, 3420 Irwin Ave., or Secretary David Spitzer, 2052 81st St., Brooklyn.

DETROIT CHAPTER had a very good year in 1958, enjoyed good attendance at its meetings in addition to visits by many NRI students and graduates.

Because of such a good year under their stewardship, all of the officers for 1958 were re-elected for another term. They are: John Nagy, Chairman; James Kelley, Vice-Chairman; Ellsworth Umbreit, Recording Secretary; Milton Oliver, Assistant Secretary; Earl Oliver, Treasurer; John Stanish and Asa Belton, Financial Committee; Charles Mills, Sergeant-at-Arms; and Prince Bray, Librarian. Congratulations to these officers on their successful past year and upon their re-election to another term!

At the conclusion of the business meeting and the elections, refreshments and sandwiches were served, and a social gathering was held so the members and the new and prospective members could get better acquainted. Everyone thoroughly enjoyed the evening.

Chapter members are busy

working on a TV panel board, which should soon be ready for use as the basis for lectures and demonstrations.

The Chapter meets at 8 P.M. on the second and fourth Friday of each month at St. Andrews Hall, 431 E. Congress St., Detroit. All NRI students and graduates will be warmly welcomed at the meetings either as guests or prospective members. Get in touch with Chairman John Nagy, 1406 Euclid, Lincoln Park, or Secretary Ellsworth Umbreit, 12523 Racine Ave., Detroit.

SOUTH EASTERN MASSACHUSETTS CHAPTER has admitted five more NRI men to membership. They are Henry Cole, Whitman; George Inglis, Whitman; Henry W. Leclair, New Bedford; Louis Perry, Mattapoiset; and Archile Pelland, Fall River. Congratulations to these new members!

The Chapter was pleased recently to act as host to guest speaker John C. Murray, a U. S. Navy Engineer. Mr. Murray delivered a fine and informative talk on TV in general, which was thoroughly enjoyed by all the members present. The meeting wound up with the customary coffee and donuts being served, during which time the members got together for the usual bull session, swapping yarns and talking about their experiences and problems in Radio-TV Servicing.

The new slate of officers elected to serve for the current year are: John Alves,



A few of the members of the Southeastern Massachusetts Chapter. Seated: Harold Araujo, Stanley Tobol, John Alves. Second row: Bill Pritchard, James Araujo, Walter Adamiec, George Fortin, Mike Kosior, Bill Wade, Art Hubert, James Veevers, Oliva Laprise, Hubert St. Pierre.

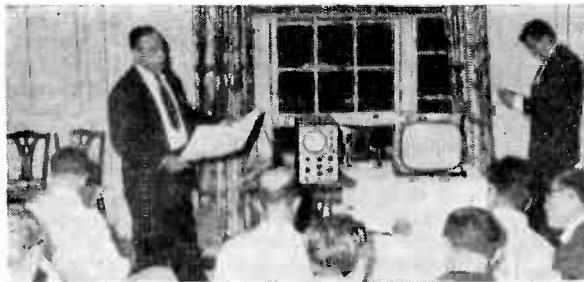

A meeting of the Southeastern Chapter at which J. B. Straughn of the NRI Staff demonstrated the new NRI Model 250 Oscilloscope.

Chairman; Bill Pritchard, Vice-Chairman; Edward Bedarz, Secretary; Edward Cacilhas, Treasurer; Oliva LaPrise, Hubert St. Pierre, Financial Committee. Congratulations to the new officers!

Meetings were heretofore held in the DAV Hall, Fall River, but the members have for some time been looking for a more suitable meeting place. Chairman John Alves generously offered to hold the meetings at his home. The members voted to accept his offer. John Alves' home at 57 Allen Blvd., Swansea, Mass., will therefore be the permanent headquarters at which the chapter will hold its meetings hereafter.

The Chapter welcomes visits from all NRI students and graduates at its meetings, either as guests or prospective members. The meetings are held at 8:00 p.m. on the last Wednesday of each month. For further information, contact Chairman John Alves at his home, or Secretary Edward Bednarz, 184 Grinnell Street, Fall River.

MILWAUKEE CHAPTER recently admitted two NRI students to membership: Gery Marquardt and Dodge Bruch. Welcome to these two new members! You will find that your membership in the Chapter will help you in your course and in acquiring a practical knowledge of Radio-TV.

The chapter has been devoting its attention to the 5-tube Radio—its troubles such as interference, distortion, shorts, hums, oscillation, etc.—and comparing these troubles with those of the TV receiver. This program is being conducted by Slavko Petrich, James Lasky, and Ralph Lassen. Erwin Kapheim has also been taking part in this program.

At one meeting, however, the 5-tube receiver was set aside in favor of a discussion and an analysis of a TV receiver brought in for the purpose by Ralph Las-

sen. This discussion and analysis was conducted by the same trio, Messrs. Petrich, Lasky, and Lassen.

The members have decided to build their own TV set with as few tubes as possible so as to have a very practical receiver for practice purposes.

The Chapter reports that all of the 1958 officers were re-elected to serve in 1959: Philip Rinke, Chairman; Slavko Petrich, Vice Chairman; Erwin Kapheim, Secretary; and Louis Sponer, Treasurer. James Lasky was

elected as Editor of the Chapter's publication, The Milwaukee News.

NRI students and graduates are cordially invited to attend the chapter's meetings, which are held on the third Monday of each month at the Radio TV Store and Shop of Slavko Petrich, 5901 W. Vliet St., Milwaukee. Get in touch with Secretary Erwin Kapheim, 3525 N. Fourth St., Milwaukee, for any additional information you would like about the meetings.

SPRINGFIELD (MASS.) CHAPTER finds that attendance at its meetings is still picking up, more and more members are coming to the meetings, apparently as the result of the Saturday night "shop" meetings at which the members tackle bench work under competent direction. This proves that the members are in favor of these shop meetings for the valuable practical experience they can get in solving Radio-TV servicing problems.

At one of these meetings Bill Planzo brought in a TV receiver which was giving



J. B. Straughn, Assistant Director of NRI Instruction Department and Chief of Consultation Service demonstrating the new NRI Model 250 Five-Inch Oscilloscope to the Springfield Chapter. At right, Lyman Brown, Technical Advisor to the Chapter, who assisted Mr. Straughn in the demonstration.



Bill Planzo entertaining guests at Springfield Chapter's Christmas Party.

him trouble with vertical sweep; Orin Hayden a set with multivibrator trouble and Augustus Lorenzetti a set with high voltage trouble. These sets were all repaired by the cooperative efforts of the members present.

At one regular Friday night meeting Chairman Rupert McLellan led a discussion on multivibrators, which the members found helpful and informative.

The Chapter is considering the purchase of parts to assemble a resistance-capacitor decade box, the assembly of which is to be assigned to one of the members.



Rupert McLellan, Chairman of Springfield Chapter; Ted Rose, Executive Secretary of NRIAA; Howard Smith, Secretary of Springfield Chapter, also President for 1958 and Vice-President for 1959; and J. B. Straughn of NRI Staff, at a recent meeting of the Springfield Chapter.

The Chapter held its customary Christmas Party at the Army Reserve Training Center, Springfield, including members, several wives and two visitors, there were twenty-nine present. Entertainment was taped organ carols, accordion music by Chapter Member Bill Planzo, and movies depicting the Christmas story. Refreshments prepared by Arnold Wilder, Chairman of the refreshment committee, and Mrs. Wilder, featured crabmeat rolls tuna

fish rolls, egg and olive rolls, fruit cake, candy and coffee. At the conclusion of the evening the guests departed cheerfully homeward to the playing of a taped parody of the Night Before Christmas.

The Chapter holds its regular meeting on the first Friday of each month, 7:00 p.m., at the U. S. Army Headquarters Building, 50 East Street, Springfield. The shop meeting is held at the shop of one of its members on the Saturday night following the third Friday of each month. All NRI students and graduates will be warmly welcomed at both the regular and the shop meetings. Those interested should contact Secretary Howard Smith, 53 Bangor St., Springfield.

MINNEAPOLIS-ST. PAUL (TWIN CITY) CHAPTER has inaugurated its new program of having two members each deliver a lecture at each meeting—one lecture on TV servicing and circuitry, and the other on new developments such as stereo sound systems.

At the first meeting at which this program was adopted, Chairman John Berka delivered a talk on TV servicing. In this talk he dealt with breaking up a TV set into its various stages and briefly explained the function of each. John Babcock then gave a very interesting talk on the advantages and requirements of a stereo sound system.

At the next meeting Chairman Berka lectured on TV tuners: how they function and what repairs the service man can make on tuners. He drew widely on his own experience in presenting actual cases he had worked on, pointed out the resistors and condensers that are most likely to fail, and gave some very valuable tips on repairing. This was followed by a talk by Paul Donatell, who went through each stage of a five tube ac-dc set, explained the function and the most prominent defects likely to occur in each.

Francis Troyer won the \$20 door prize drawing held at this meeting. This door prize money must be applied toward the winner's purchase of test equipment. The money for the door prizes is accumulated by each member paying twenty-five cents at each meeting he attends.

These meetings are held at Walt Berbee's Radio-TV Shop, 915 St. Clair, St. Paul, at 8:00 p.m. on the second Thursday of each month. All NRI students and graduates in the area are cordially invited to the meetings. If you have not attended any of the meetings and would like to do so, get in touch with Chairman John Berka, 2833 42nd Ave., St. Paul, Minneapolis.

LOS ANGELES CHAPTER was so pleased with its 1958 Officers that it re-elected all of them to serve during 1959, with the single exception of the former treasurer, Clarence Adams, who could not be a candidate for re-election because he is attending night school for the study of advanced Electronics.

The officers to serve during the current year are Thomas McMullen, Chairman; William Edwards, Vice-Chairman; Earle B. Allen, Secretary; and Mike Raftis, Treasurer. Congratulations to these officers!

Two new members were recently admitted, Frederick Tennis and Henry Dominguez. A warm welcome to these two new members.

The Chapter extends an equally warm welcome to all NRI students and graduates in the area who would like to attend the meetings either as guests or prospective members. The meetings are held at 8 P.M. on the second Friday of each month at St. Joseph's Catholic School Hall, 1220 S. Los Angeles St., Los Angeles. For more information about these meetings get in touch with Chairman Thomas McMullen, 1002 W. 187th Place, Gardena, or Secretary Earle B. Allen, Jr., 11523 S. Broadway St., Los Angeles.

FLINT (SAGINAW VALLEY) CHAPTER continues to meet at 7:30 P.M. on the second Saturday of each month at Vice-

Chairman Aaron Triplett's Repair Shop, 2538 Walcott St., Flint.

The Chapter extends a cordial invitation to all NRI students and graduates in the Saginaw Valley to attend the meetings either as guests or prospective members. Those interested should contact either Vice-Chairman Aaron Triplett or Secretary George L. Hinman, 603½ State St., Bay City, Mich.

PITTSBURGH CHAPTER at its December meeting was visited by J. B. Straughn, Assistant Director of the NRI Instruction Department, and Chief, Consultation Service, and Ted Rose, Executive Secretary of the NRI Alumni Association.

Mr. Straughn's purpose in attending the meeting was to deliver a talk on the use of the oscilloscope in Radio-TV Servicing. He gave a visual demonstration of signal tracing in a 17-inch Dumont TV receiver, during which he employed the new NRI Model 250 Five-Inch Oscilloscope. In this demonstration Mr. Straughn was ably assisted by Tom Schnader.

At this same meeting the Chapter members elected its new officers to serve during 1959. They are: Thomas D. Schnader, Chairman; Howard A. Tate, Vice-Chairman; Raymond G. Bender, Secretary; Lawrence J. Stapf, Treasurer; Frank P. Skolnik, William J. Lundy, and David C. Denes, Executive Committee.



Officers of the Pittsburgh Chapter and guests. Seated, l to r: Thomas Schnader, Howard Tate, Raymond Bender. Standing: guests T. E. Rose and J. B. Straughn, Lawrence Stapf, William Lundy, Frank Skolnik, David Benes.

The new officers plan to institute a new procedure to be followed at the meetings in order to expedite lectures and demonstrations at the meetings.

At a previous meeting Tom Schnader gave an excellent demonstration of radio defects by introducing leakage and shorts into the chapter's radio demonstrator and then tracing the loss of signals with a signal tracer. By-pass and coupling capacitors were shorted and bridged with resistors, the effect was noted and then explained.

All NRI students and graduates are cordially invited to attend the chapter's meetings, which are held at 8:00

p.m. on the first Thursday of each month at 134 Market Pl., Pittsburgh. For further information, get in touch with Chairman Tom Schnader, R. D. 3, Irwin, or Secretary Ray Bender, 2626 Norwood St., Pittsburgh.

HAGERSTOWN (CUMBERLAND VALLEY) CHAPTER attended a Sylvania Clinic held at the Alexander Hotel in Hagerstown, on stereo and TV. One of the features of the Clinic was to demonstrate the trouble spots encountered in TV servicing. Each member received numerous manuals on Sylvania TV, Hi-Fi, and Stereo. It was a very fine presentation, enjoyed by all.

The Chapter has been concentrating on general discussions of the servicing problems of its individual members. Much

valuable help and information is gained by all members from these general discussions.

At its December meeting the Chapter elected the Officers to serve for the current year, as follows: Reginald S. Ankeney, Chairman; Melbourn H. Foreman, Vice-Chairman; Edwin M. Kemp, Secretary; and Robert K. Saum, Treasurer. Congratulations to these officers!

The Chapter meets at 8 P.M. at the North-end Hagerstown Senior High School, Hagerstown, on the second Wednesday of each month. All NRI students and graduates in the Cumberland Valley are cordially invited to the meetings. For more information about the Chapter's activities and meetings get in touch with Secretary Edwin M. Kemp, 618 Sunset Ave., Hagerstown.

— n r i —

Hi-Fi Corner

(Continued from page 15)

duce less distortion. This characteristic causes a peculiar situation in that a low-frequency tone fed to a package system could cause a louder output than the same tone fed to a good component system. You see, the human ear is less sensitive at low frequencies than mid-frequencies.

Q. I get it, the "package" is putting out loud distortion but the "component" is putting out low but true sound. I'm surprised, though, about that 80% to 90% figure. It seems to me the bass should sound a lot worse than it does!

A. You're right and it would except for another characteristic of the human ear. That is—automatic substitution of the missing fundamental. When the ear hears a distorted reproduction of a low note, it automatically impresses the brain to cause you to believe you heard what you didn't. Of course, there has to be a good bit of the true sound present and the listener has to be familiar with the particular sound his ear is attempting to "synthesize."

Q. If the ear then corrects poor speakers, why have good ones?

A. Because the ear can't correct that well. It might be able to help you distinguish a tuba from a drum but it will still sound like a pretty sick tuba! Besides the necessity of too much "ear correction"

along with ragged response causes "listener fatigue."

Q. Listener fatigue? Quit kidding!

A. No, it is true. It is an, as yet, immeasurable but definitely true characteristic that causes you to turn down or turn off the sound before you're really through listening to it. Lack of "listening fatigue" permits the Hi-Fi addict or audiophile to listen to his rig at loud volume for many hours.

Q. I think "bats in the belfry" help some of those audiophiles, too!

A. True, many are more interested in sound effects than music. But those of us who enjoy good music know that, since an orchestra or even a quartet is naturally loud, we must play back the music at loud levels to get more natural sound.

Q. That word "natural," then, is the key to the whole thing. Component high fidelity is more "natural" than package.

A. You're catching on but we call it "presence."

Q. All in all, then, would you recommend that I purchase a component system rather than a package system?

A. No—buy what suits you best. If you are primarily interested in best sound quality, the component system is for you. If you just want a good phonograph and a nice piece of furniture, buy "package."

The Essence Of Leadership

What are the ingredients of leadership? What makes one man stand head and shoulders above the crowd, while another is content to follow?

One great lesson emerges from a study of three men—a statesman, a business executive, a sports hero: no one is born a leader.

The qualities of leadership must be cultivated.

Consider the case of the man many political commentators call “the world’s greatest living statesman.” Perhaps no name today is so synonymous with the word **leadership** as that of Sir Winston Churchill.

Yet, Sir Winston’s life was peppered with failures. The big difference is that the man who later helped to forge the Western Alliance and defeat the Axis Powers early learned how to turn seeming failure into success. In the process, he became an outstanding leader of men.

Sir Winston still vividly recalls the first major set-back of his life. As a schoolboy at Harrow, he did not do well in the study of Latin and Greek. Consequently, his teachers decided to let him concentrate on English only. In his own published words: “As I remained in the third Fourth three times as long as anyone else, I had three times as much of it. I learned it thoroughly. Then I got into my bones the essential structure of the ordinary British sentence—which is a noble thing. And when in after years my school fellows who had won prizes and distinction for writing beautiful Latin poetry had to come down again to common English, I did not feel myself at any disadvantage. Naturally I am biased in favour of boys learning English. I would make them all learn English . . . The only thing I would whip them for would be for not knowing English. I would whip them hard for that.”

He may have never learned Latin, but 50 years later his stirring speeches to the English, in their moment of peril, filled them with the bulldog determination that eventually led to Hitler’s defeat. And, a decade later, when he was awarded the Nobel Prize for literature, it came as no particular surprise to anyone.

Which isn’t bad for a boy who was once last in his class.

Two lessons emerge from even a brief con-

sideration of Sir Winston: a leader knows how to learn from his mistakes; and he knows how to express himself.

Cross the Atlantic now and meet an American business executive who, in five years, almost **tripled** the assets of a company that was big to begin with.

The man—Donald Clinton Power. The company—General Telephone System.

When Mr. Power, a lawyer and telephone-rate expert, assumed the presidency of General Telephone in June, 1951, it was even then America’s largest independent telephone company, with assets of \$305,000,000.

But it was little more than a holding company—a loosely knit federation of regional telephone companies, each of which managed its own area without much assistance or supervision from the central office.

Recognizing a potential for growth, Mr. Power set two objectives: to centralize the organization, establishing uniformity of procedures and specifications; and to acquire a manufacturing division.

To work in the headquarters office, Mr. Power hired top experts in personnel . . . advertising . . . rates . . . law . . . operations and other fields. Managers of regional operating companies soon had available to them a wealth of facts and advice based on the centrally collected experiences in other divisions. By the end of 1956, General’s assets had risen to \$850,000,000.

Today, the company is well over the **billion** dollar mark. And the company is **still** growing, operating, thanks to Power-hired experts who predict areas of population increase, in many of the fastest-growing areas of population increase, in many of the fastest-growing areas of the country!

From this man’s career, we can extract these lessons: a leader seeks to rise, no matter how high he may be; he sets specific objectives to guide him; he doesn’t stint in calling upon people with specialized skills.

Go back for a moment to the Baltimore of 1902. A seven-year-old boy is being left at St. Mary’s Industrial School, an institution for underprivileged children. He is a warmhearted, engaging kid, but his environment has been such that he seems a good bet to end up a mobster. Every-

thing is against him—except his ability to throw a baseball.

His name is George Herman Ruth.

Baltimore was a famous baseball town, and a boy with big hands and strong arms was likely to be noticed by Big League scouts. At 19, George, better known as Babe, joined the Baltimore Orioles as a left-handed pitcher for \$600 a year. Before he was 20, he was sold to the Boston Red Sox and earning \$1,300 a year.

An up-and-coming pitcher, he found himself sold to the New York Yankees for \$125,000 in 1919. The yanks switched him to the outfield, and for the next ten years he was baseball's greatest star, a constant inspiration to his teammates. The home runs rolled in: 54 in 1920; 59 in 1921; an incredible 60 in 1927. By the end of the decade, he was earning a colossal \$80,000 a year—virtually tax-free!

In his last World series, Ruth faced a razzing Chicago crowd. When the Cubs, pitcher, Charley Root, threw the ball, the Babe swung with all his power—and missed. The crowd jeered. Root threw again, Ruth swung the bat mightily, his hulking body pirouetting completely around as he sliced the empty air. Strike two! The boos mounted to a roar.

Then Ruth rubbed a little dirt on his

hands, raised one arm and pointed toward the flagpole in center field. The jeers rose to a crescendo of contempt.

Root wound up and threw the ball. The Babe swung easily, almost effortlessly, and the clean crack of wood meeting leather resounded through the park. A blur of white sailed up, up, past the flagpole and out of the park—for Babe Ruth's most famous home run.

In 1934, when the Yankees retired Ruth's No. 3 uniform, a teammate was heard to say. "I'd go anywhere in the world for the God-granted privilege of playing on the same team as the Babe."

The Sultan of Swat provides us with the final rules: a leader keeps going even when everyone jeers; he demands—and gets—that extra bit of effort out of himself.

To sum up, "Mr. Leader:"

- Learns from his mistakes.
- Knows how to express himself.
- Seeks to rise higher and higher.
- Sets specific objectives to guide him.
- Calls on people with specialized skills.
- Keeps going, even when everyone jeers.
- Gets that extra bit of effort out of himself.

— n r i —

— n r i —

ANTENNA TOPS ONE OF TALLEST STRUCTURES IN U.S.

Addition of a 126-foot traveling-wave television antenna to the lofty new tower built for WIS-TV, Columbia, S. C., will give that station one of the tallest man-made structures in the United States.

The WIS-TV tower stands 1,526 feet high, more than fifty feet taller than New York City's Empire State Building and its broadcast antenna mast.

The traveling-wave antenna is a pole-like unit with radiating slots along its length in place of the protruding elements used in other antenna types. The traveling-wave antenna's name comes from its design which permits the transmitted broadcast signal to travel the length of the unit as a complete wave.

The traveling-wave antenna design makes possible ideal shaping of the vertical

broadcast pattern, improved signal distribution, simplified construction and economical operation while achieving desired power gain in the very-high frequency television broadcast band.

The new antenna, with a power gain of 18, enables WIS-TV to broadcast with effective radiated power of 316,000 watts, greatly increasing the station's coverage area. Construction of the WIS-TV supporting tower began early in August, at a site eighteen miles northeast of Columbia along South Carolina State Highway 12.

G. Richard Shafto is Executive Vice President, and Charles A. Batson is Managing Director of WIS-TV, which is owned and operated by the Broadcasting Company of the South.

WHAT IS AN AMERICAN?

BY HAROLD W. RUOPP
Minnesota Council of Churches

*This is published in the interest of Brotherhood Week, February 15-22,
sponsored by the National Conference of Christians and Jews.*

AN AMERICAN is one who believes in the right of men and women of whatever, creed, class, color or ancestry, to live as human beings with the dignity becoming the children of God.

AN AMERICAN is one who believes in the right to be free; free not only from crushing coercions and dictatorships and regimentation, but free for that way of life where men may think and speak as they choose and worship God as they see fit.

AN AMERICAN is one who believes in the right to vote, the right to work, the right to learn, the right to life, and—what is equally important—in the right to be different; for he knows that if we ever lose the right to be different we lose the right to be free.

AN AMERICAN is one who believes in democracy, not only for himself but for all his fellow-Americans. By democracy he means not simply the rule of the majority but the rights of minorities; and those minorities have rights, not because they are minorities, but because they are human beings.

AN AMERICAN is one who believes in the responsibility of privilege. What he asks for himself, he is willing to grant to others; what he demands from others, he is willing to give himself. His creed is not alone, "Live and let live," but "Live and help live."

AN AMERICAN is one who acts from faith in others, not fear of others; from understanding, not prejudice; from goodwill, not hatred. To bigotry he gives no sanction; to intolerance no support.

The only question THE TRUE AMERICAN ever asks is not, Are you a Protestant or Catholic, Gentile or Jew, white or colored, but, Are you an American? If you are, then give me your hand, for I am an American too.

Newly Developed Machine Can Test Up to 2,500 Tubes Per Hour.

A new multiple-function tube testing machine which can test up to 2,500 electron tubes per hour has been developed by the RCA Electron Tube Division, it was announced by D. Y. Smith, Vice President and General Manager.

Four of these machines, are in use at RCA tube manufacturing centers in Harrison, Cincinnati and Indianapolis. More units will be installed at plants as additional machines are completed. The equipment will be for sale to other manufacturers of electron tubes.

Each machine can perform up to fifteen individual electrical tests on more than forty miniature receiving tubes per minute. Loading is accomplished by an operator inserting tubes per minute. Loading is accomplished by an operator inserting tubes directly into sockets or placing them in an automatic loading device. Unloading is done automatically.

A unique feature of the factory tube tester is a system of programming that establishes the test criteria for different tube types. Programming boards, containing a maze of spaghetti-like wires, can be plugged into the device in less than a minute. These boards can be preset according to the testing schedule and are interchangeable within themselves. A complete change-over from one tube type to another can be made in about twenty minutes.

These testing machines also offer several important advantages for immediate controls in our manufacturing process. For example, mechanical counters register the number of tubes tested, the net of good-tube output, and the quantity and reasons for any rejections. As a result, flaws can be detected promptly and corrective process controls quickly instituted.

The machines pre-heat and then test seven- or nine-pin miniature tubes used for radio, television, and industrial applications. Tests are performed for short circuits, discontinuity, gas content, plate and screen currents, transconductance, emission, frequency noise, power output, and ballistic microphonics. These tests are made for both high and low limits when necessary. During each cycle the machines also perform three tests as a control on its own circuits."

How Factory Tube Testing Machine Works

An operator inserts the tubes into sockets on a conveyor, or into a chute if tubes are to be automatically loaded. As the tubes travel along the conveyor, they are pre-heated and tested for electrical performance at various stations. Tubes not meeting specifications are ejected at the respective testing station and passed into storage bins labeled with the type of rejection. Tubes meeting all specifications continue to the final station where they are fed into the "good tube" compartment.

— n r i —

— n r i —

RCA Becomes First Electronics Manufacturer to Merchandise All-New and Factory-Rebuilt TV Picture Tubes

Two distinct lines of television picture tubes for black-and-white sets—an all new premium line and an economy-priced factory rebuilt line—will be marketed by the RCA Electron Tube Division this year.

RCA is the first major electronics manufacturer to merchandise a dual line of all-new and rebuilt picture tubes on a national brand basis.

The premium line of picture tubes will be constructed from all-new materials. Each tube will use all-new glass, an all-new screen and all-new components.

The rebuilt picture tube line, manufactured under strict factory supervision and control, will be an economy-priced, quality, product for the replacement market.

In Memorium

NRI News records with deepest regret the death of Mr. John A. Dowie, former Chief Instructor of NRI who passed away December 3, 1958 after a short illness.

Chief Dowie, the first employee at NRI to retire at age 65, was a real oldtimer in the Radio field. Born May 28, 1886, in London, England, he attended high school and Polytechnic Institute there before coming to this country. Here, he furthered his education at the Chicago Electrical School, Marconi Institute in New York and Penn State College. Chief Dowie joined



John A. Dowie

the NRI Staff in 1915 as Radio Theory Instructor and in Mr. Smith's own words, he was "my right-hand man."

As a member of The Institute of Radio Engineers, author of "The Science of Modern Radio Merchandising" and many other contributions to Radio magazines, Mr. Dowie ranks among the leading Radio authorities of his day. He was retired on May 25, 1951—after 36 years of service.

On December 23, 1958, as a personal tribute to Chief Dowie, J. E. Smith our beloved founder stated: "Mr. Dowie's deep desire during his life at NRI was to render as much personal service to each individual student as his energy and time permitted. He was unusually devoted to his work and found a great deal of satisfaction in rendering service to others."

Portable Receivers Using Transistors

(Continued from page 6)

amplifier. When a strong signal is received, considerable positive avc voltage is developed and this is fed to the base of the i-f amplifier. This positive voltage reduces the negative voltage and hence the forward bias of the emitter-base junction. This reduction in forward bias reduces the flow of holes through the transistor to the collector. This in turn reduces the number of electrons flowing to the collector, and hence the current through the 2.7K resistor R9 decreases. This causes the voltage drop across R9 to decrease, and the collector voltage on the first i-f transistor to increase. This reduces or eliminates the reverse bias on the overload diode and since, insofar as the signal is concerned, it is directly across the primary of the input i-f transformer, it loads it, reducing its Q, and hence the output from the transformer. Incidentally, notice that for the PNP transistors the avc voltage developed is positive; it is quite different from the avc voltage developed in vacuum tube receivers, which is always negative.

Insofar as the converter and first i-f stage of this receiver are concerned they are practically identical to those in the preceding receiver. In the converter stage the rf signal is mixed with the oscillator signal, and the i-f is produced. The i-f signal is amplified by the first i-f stage and fed to the second i-f amplifier. Now let's go through the second i-f amplifier and detector circuits to see how the second i-f amplifier is used to amplify both the i-f signal and also the audio signal from the output of the second detector.

The amplified signal from the first i-f stage is developed across the inter-stage i-f transformer T-2. There will be an i-f signal voltage developed between terminals 2 and 3 of the secondary winding of T2. Terminal 3 is connected directly to the base of the second i-f transistor, and terminal 2 is connected to the emitter through the .05-mfd capacitor C11. Thus, the signal is applied between the emitter and the base of the transistor. The i-f signal is amplified by this transistor. The amplified signal is developed across the primary of the output transformer T3.

Notice that the second i-f stage is neutralized by the signal fed from terminal 4 of the output i-f transformer through the 12K resistor R12 and the 5.6 mmf capacitor C10 back into the base of the transistor. The signal fed through this circuit will cancel out any signal energy fed from the collector back into the input circuit through the transistor itself.

The amplified i-f signal current flowing through the primary winding of the output transformer T3 will induce a voltage in the secondary. When the polarity of the i-f signal voltage developed in the secondary is such that terminal 2 of the secondary is positive, terminal 3 will be negative, and current will flow from terminal 3 through the 2.5K volume control R15, through the diode detector CR1, through the secondary of T3, and back to terminal 3. The strength of this current will depend on the strength or amplitude of the i-f signal, and the audio component will depend on the modulation on the i-f signal. Thus, an audio signal voltage will be developed across the volume control and across the .05-mfd capacitor C15. We are concerned with the audio signal voltage developed across the volume control.

Notice that the side of the volume control that connects to the .05-mfd capacitor C15 and terminal 3 of the output i-f transformer is grounded. The audio signal voltage is taken from the side of the volume control that is grounded and the adjustable arm on the potentiometer, and applied to the base and emitter of the second i-f amplifier. The further the adjustable arm is turned toward the end of the volume control that connects to the germanium diode, the greater the audio signal voltage will be. In any case, the audio signal voltage is fed from the adjustable arm, through the 1.5K resistor R19 and through the 1-mfd capacitor C14 to terminal 2 of the secondary winding of the interstage i-f transformer T2. The secondary of T2 has a very low impedance at the audio-signal frequency, so the audio signal is fed through the secondary winding of this transformer to the base of the transistor just as though there were a direct connection to the base. The emitter of the second i-f transistor is operated at ground potential for both the audio and i-f signals, because it is grounded through the 90-mfd capacitor C12. Therefore, since the end of the volume control is also grounded, we have the audio signal applied between the base and the emitter of the second i-f amplifier.

This audio signal applied between the base and the emitter of this transistor will cause an audio variation in the holes flowing from the emitter to the collector. Thus we will have an audio variation in the current flowing through the primary of T3. This current flows from the negative terminal of the battery (in the lower right corner), through the primary winding of the input audio transformer T4 to terminal 6 on the output i-f transformer to terminal 1, from terminal 1 to the collector of the second i-f transistor. Thus a varying audio current flows through the primary wind-

ing of the input audio transformer T4. This will induce an audio signal voltage in the secondary of T4 and this signal voltage is applied to the bases of the two transistors used in the push-pull output stage. The collector currents are combined in the primary winding of the output transformer T5, and the varying current through this winding will induce a voltage in the secondary of T5, which in turn will cause a current to flow through the transformer secondary and through the speaker voice coil.

Now the question that immediately comes to mind is why the two signals being amplified by the second i-f stage do not interfere with each other. As far as the audio signal is concerned, it will not cause any trouble by flowing through one winding of the i-f transformers T2 and T3, because they have such a low impedance at audio frequencies that the audio signal flowing through one winding will not induce any voltage in the other winding. As far as the i-f signal is concerned, the signal will not flow from terminal 2 of the interstage i-f transformer T2 back into

The best way to forget all of your other troubles is to wear tight shoes.

the detector circuit because terminal 2 of this transformer is effectively at i-f signal ground potential. It is grounded, insofar as the i-f signal is concerned, through the .05-mfd capacitor C11 and the 90-mfd capacitor C12. It is not grounded as far as the audio signal is concerned, because the reactance of the .05-mfd capacitor C11 at audio frequencies is high compared to the low input impedance of the transistor. Similarly, the output circuit of the transistor amplifier is grounded insofar as the i-f signal is concerned, because terminal 6 is connected to ground through the .02-mfd capacitor C13 and the 90-mfd capacitor C12. So the i-f will not flow through the primary of T4.

However, in spite of these precautions to keep the two signals separated, there is some feed-through in a reflex circuit. The problem is not due to the signals getting mixed up, but rather to the fact that the second i-f amplifier is not perfectly linear. You will remember that we said that a non-linear device will act as a detector. Because there is some nonlinearity in the transistor, a certain amount of detection will occur. Thus there will be a weak audio signal developed in the second i-f stage which will flow through the primary winding of T4. The signal will then be amplified by the output transistors.

Under normal operating conditions when the volume control is turned up to a reasonable level this does not cause any trouble, because the audio signal being fed from the detector back to the second i-f stage and then amplified by it, is usually so much stronger than the audio signal being produced by the second i-f amplifier acting as the detector, that the desired signal overrides the audio signal being produced in the second i-f stage. However, if you turn the volume control to a very low volume position it may cause distortion, and even if the volume is turned down completely there will usually still be some sound coming from the speaker. This is due to detection in the second i-f amplifier.

A number of manufacturers have put out sets using reflex circuits. The advantage of this type of receiver over the set using conventional stages is that one transistor can be omitted. Thus the five-transistor receiver shown in Fig. 5 will give you essentially the same performance as a receiver using six transistors in which no reflex circuits were used. The disadvantage of this type of receiver is in the feed-through that occurs due to detection in the i-f amplifier that is serving both as an i-f amplifier and an audio amplifier.

SUMMARY

Most modern portable receivers use transistors rather than vacuum tubes. Transistors are used because of their modest voltage and current requirements.

Transistor portables are generally smaller than vacuum tube portables. They can be made much smaller because transistors themselves are small, and because special miniature components are usually used in them. Also heat is not a big problem in these sets and therefore the parts can be put very close together.

Most transistor receivers use an etched circuit board. The etched circuit board is a phenolic board on which copper that has been put on the board makes the connections between parts so that no wires or leads are required to connect the various components together.

Portables may have as few as four transistors, but it is not uncommon for them to have 6 or more. Portable receivers using transistors are often made very small. Some of the smaller portables can actually be slipped into a man's shirt pocket. Some transistor portables are made somewhat larger in order to accommodate a better speaker to get better tone.

Often there will be two transistors used



in a push-pull output stage in these receivers. The transistors used in the output stage are usually called a "matched pair." This means that the transistors are selected to have nearly identical characteristics in order to give best results in the receiver. If it should be necessary to replace one of these two transistors, you may find that you have to replace both the transistors in the output stage with another matched pair. Most transistor manufacturers supply output transistors in matched pairs so the serviceman can replace both transistors in the output stage when he must do so.

— n r i —

EXTRA EFFORT

The great Thomas Edison had a very beautiful summer house in which he took great pride. One day while showing some guests about, he pointed out all the labor saving devices he had around the place. Turning back to the house, it was necessary to pass through a turnstile which led onto the main path. To get through the device took considerable effort.

"Mr. Edison," asked a guest, "how is it that with all these wonderful things around here, you still keep such a heavy turnstile?"

"Well, you see, replied the great inventor, "everyone who pushes the turnstile around pumps eight gallons of water into the tank on my roof."

*from The Good Word
Baltimore, Md.*

NRI NEWS

**3939 Wisconsin Ave.
Washington, D. C.**

Second-class mail
privileges authorized
at Washington, D. C.

Mr. Lester N. Rodgers
3 Water St.
Christiana, Penna.

E30-D322-G

4A